

CABLE RESISTANCE THERMOMETER

Type XI-TOPE550

Resistance thermometers XI-TOPE550 are designed for screw-fitting directly into machine parts or bearings. Sensor can be applied in hard to reach places where small size of thermowell is required.

The sensor consists of thermometric resistor, protection tube, moveable threaded process connection and cable.

Insertion length, process connection, construction type, number of sensors, accuracy, cable insulation and method of connection can be selected individually for the respective application.

TECHNICAL DATA

Description

- Intrinsicly safe for mines MI, gas G and dust D atmospheres
- Single RTD
- Moveable slotted grub screw

Design temperature range

-10.. +105°C	with cable in PVC
-50.. +180°C	with cable in silicone rubber
-50.. +260°C	with cable in teflon® PFA
-50.. +400°C	with cable in fiberglass

Sensing element

1x or 2xPt100	Class A or B, acc. to PN-EN 60751
---------------	-----------------------------------

Protection tube

Material	stainless steel 1.4541**
Diameter [mm]	Ø3, Ø4, Ø5, Ø6, Ø8*
Length L [mm]	custom

Connection cable

JJ	PVC / PVC (up to +105°C)
SLSL	silicone / silicone (up to +180°C)
TSL	teflon® / silicone (up to +180°C)
TPSL	teflon® / Cu braid / silicone (up to +180°C)
TT	teflon® PFA / teflon® PFA (up to +260°C)
TP	teflon® PFA / steel braid (up to +260°C)
TCuT	teflon® PFA / Cu braid / teflon® PFA (up to +260°C)
GLGLP	fiberglass / fiberglass / steel braid (up to +400°C)

Remarks

* other parameters upon request

ATEX Marking:

- CE I MI Ex ia I Ma
- CE II 1/2 G Ex ia II C T... Ga/Gb
- CE II 1/2 D Ex ia IIIC T... Da/Db

IECEx Marking:





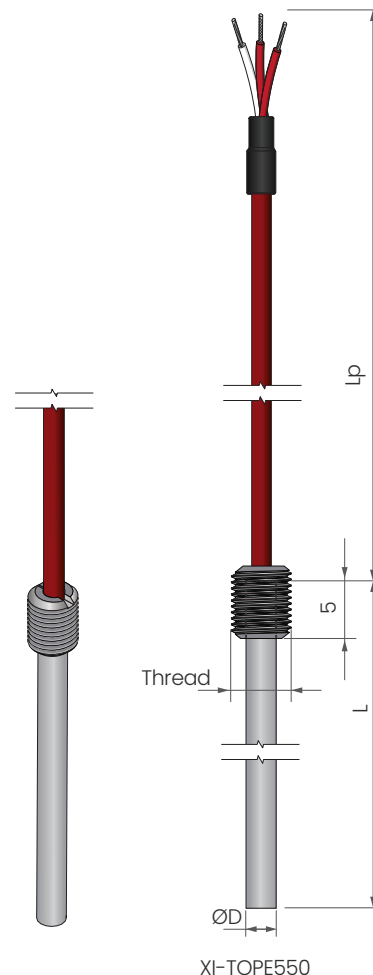

- Ex ia I Ma,
- Ex ia IIC T ...Ga
- Ex ia IIIC T ...Da



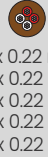

EAC Ex Marking:

- PO Ex ia I Ma X
- 0Ex ia IIC T...Ga X
- 0Ex ia IIIC T...Da X

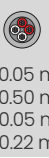
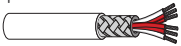
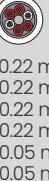

List of available connection cables.

Connection cable	cross	diameter	code
up to +105°C. 			
PVC / PVC	4 x 0.22 mm ²	Ø4.4	JJ-4x0.22mm ²
up to +180°C. 			
silicone / silicone	3 x 0.22 mm ²	Ø3.4	SLSL-3x0.22mm ²
up to +180°C. 			
teflon® FEP / silicone	2 x 0.22 mm ² 3 x 0.22 mm ² 4 x 0.22 mm ² 6 x 0.22 mm ² 8 x 0.22 mm ²	Ø4.2 Ø3.8 Ø3.8 Ø4.4 Ø5.0	TSL-2x0.22mm ² TSL-3x0.22mm ² TSL-4x0.22mm ² TSL-6x0.22mm ² TSL-8x0.22mm ²
up to +180°C. 			
teflon® FEP / Cu braid / silicone	3 x 0.22 mm ² 4 x 0.22 mm ² 6 x 0.22 mm ² 8 x 0.22 mm ²	Ø3.9 Ø4.0 Ø4.2 Ø4.4	TPSL-3x0.22mm ² TPSL-4x0.22mm ² TPSL-6x0.22mm ² TPSL-8x0.22mm ²

Connection cable	cross	diameter	code
up to +260°C. 			
teflon® PFA / teflon® PFA	2 x 0.22 mm ² 3 x 0.22 mm ² 4 x 0.22 mm ²	Ø2.5 Ø2.6 Ø2.6	TT-2x0.22mm ² TT-3x0.22mm ² TT-4x0.22mm ²
up to +260°C. 			
teflon® PFA / steel braid	3 x 0.05 mm ² 3 x 0.50 mm ² 4 x 0.05 mm ² 4 x 0.22 mm ²	Ø1.7 Ø3.5 Ø2.0 Ø3.6	TP-3x0.05mm ² TP-3x0.50mm ² TP-4x0.05mm ² TP-4x0.22mm ²
up to +260°C. 			
teflon® PFA / Cu braid / teflon® PFA	3 x 0.22 mm ² 4 x 0.22 mm ² 6 x 0.22 mm ² 8 x 0.22 mm ² 6 x 0.05 mm ² 8 x 0.05 mm ²	Ø3.1 Ø3.9 Ø4.1 Ø4.6 Ø2.6 Ø3.0	TCuT-3x0.22 mm ² TCuT-4x0.22 mm ² TCuT-6x0.22 mm ² TCuT-8x0.22 mm ² TCuT-6x0.05 mm ² TCuT-8x0.05 mm ²
up to +400°C. 			
fiberglass / fiberglass / steel braid	4 x 0.22 mm ² 6 x 0.22 mm ²	Ø3.8 Ø5.0	GLGLP-4x0.22 mm ² GLGLP-6x0.22 mm ²

ORDERING CODE

Temperature sensor		XI - TOPE550 - [] - [] - [] - [] - [] - [] - [] - []							
sensing element:	1xPt100 <input type="checkbox"/> 2xPt100 <input type="checkbox"/>	1xPt500 <input type="checkbox"/> 1xPt1000 <input type="checkbox"/>							
diameter [mm]:	3, 4, 5, 6, 8 or other* <input type="checkbox"/>								
length L [mm]:	custom <input type="checkbox"/>								
cable length L _p [mm]:	custom <input type="checkbox"/>								
RTD class:	A, B <input type="checkbox"/>								
connection line:	2, 3, 4 wire for 1xPt100 <input type="checkbox"/>								
thread:	M8 <input type="checkbox"/> M10x1 <input type="checkbox"/> M12x1 <input type="checkbox"/> M12 x1.5 <input type="checkbox"/> or other* <input type="checkbox"/>								
cable insulation	(see specification) <input type="checkbox"/>								

EXAMPLE: Temperature sensor XI-TOPE550-1xPt100-3-30-2500-A-4-M8x1-TT

1 2 3 4 5 6 7 8

Temperature sensor XI-TOPE550-1xPt100-5-50-1000-A-3-M10x1-TP

1 2 3 4 5 6 7 8