

Applications

- Temperature measurement of pipelines and other cylindrical elements
- General industrial services

Features

- Single or double thermocouple
- Sensing element according to (PN-EN 60584-1):

Type K (NiCr-NiAl),
Type J (Fe-CuNi),
Type N (NiCrSi-NiSi),
Type E (NiCr-CuNi),
Type T (Cu-CuNi)

- Non-standard sensor versions available upon customer's request:
 - cable type according to client's specification
 - thermowell spring protection against excessive cable bending

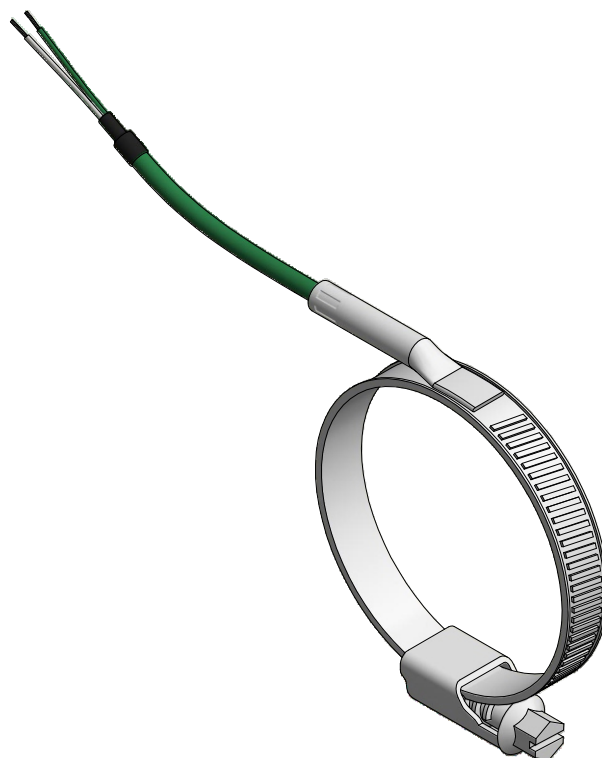

TTE50244S
TSL cable insulation
(teflon®FEP/silicone)

Thermocouples TTE50244S are designed for assembling directly onto pipelines or other cylindrical elements.

Hose-clip allows to mount sensor on pipeline. Sensors designed for pipeline diameter greater than Ø100 mm are equipped with two or more hose-clips.

The sensor consists of thermocouple cable, protection tube made out of stainless steel and hose-clip.

Thermocouple type, accuracy, cable length and insulation can be selected individually for the respective application.

Temperature transmitter (Option)

There is possibility of using standard temperature transmitter (4÷20mA, 0÷10V) or temperature transmitter with HART®, Profibus® PA, Foundation Fieldbus communication protocol, mounted inside electrical control cabinet.

ATEX, IECEx, EAC Ex versions

Intrinsically safe designs are available for applications in hazardous areas. These models are provided with certificate for „intrinsically safe“ type of protection according to Directive 2014/34/UE (ATEX), IECEx scheme and EAC Ex TR-CU 012/2011 (Eurasian Economic Union).

Intrinsically safe (Exi) XI-TTE50244S

Designs

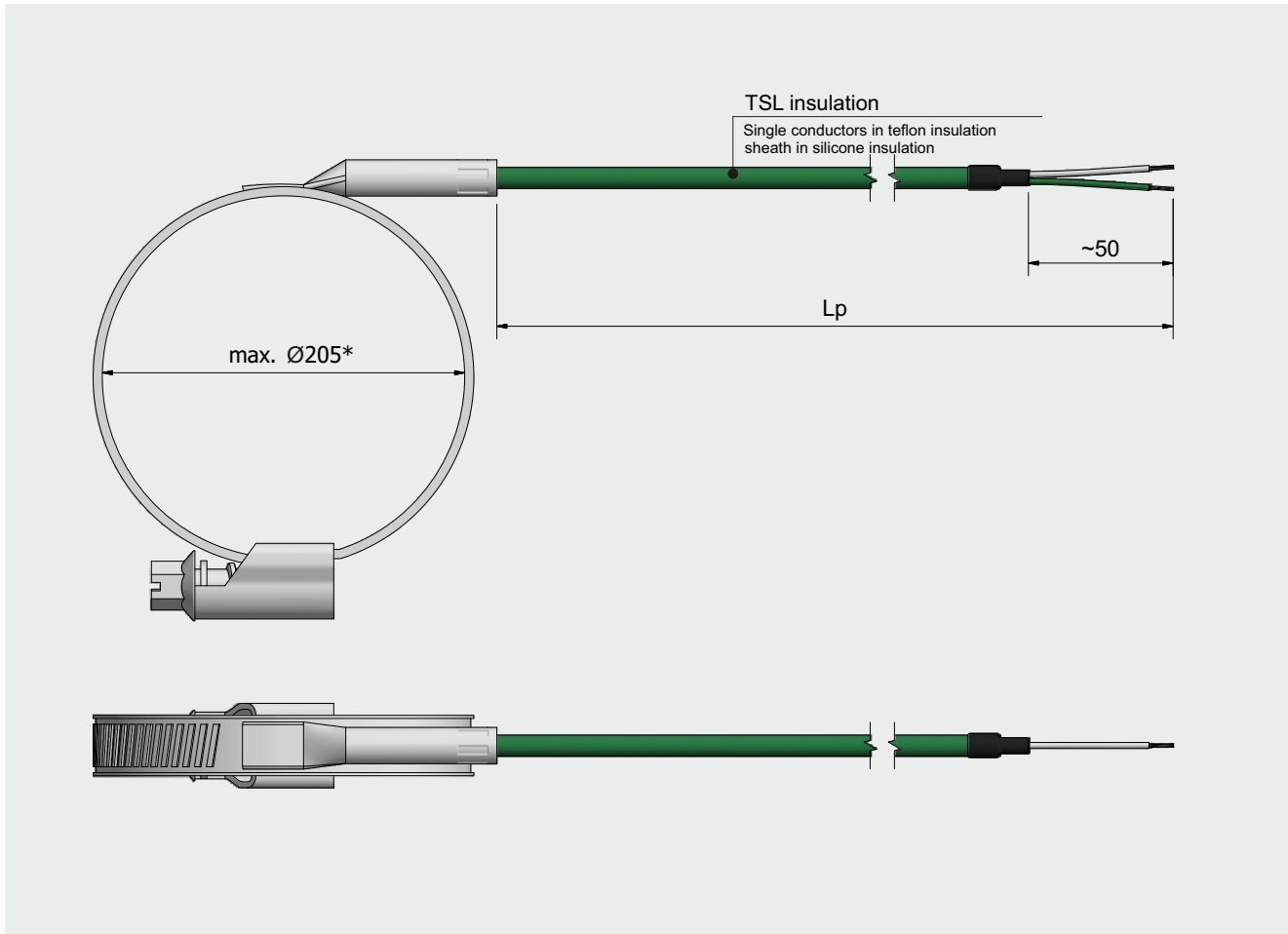

* Diameter > Ø205 are available for special client's request

Basic values of Thermocouples type J, K, N according to PN-EN 60584 / IEC 584

Temperature		°C	100	200	300	400
Basic value	Type J	mV	5.27	10.78	16.33	21.85
	Type K	mV	4.10	8.14	12.21	16.40
	Type N	mV	2.77	5.91	9.34	12.97
Tolerance	Class 1	°C	±1.5	±1.5	±1.5	±1.6
	Class 2	°C	±2.5	±2.5	±2.5	±3.0

Tolerance

The PN-EN 60584 Standard defines the formulas for calculating acceptable measure tolerance. More information available in the general thermoelectric thermometer sheet.

Electrical parameters

Isolation resistance > 10 GΩ (test 500 VDC)

Housing material

Stainless steel 1H18N9T (1.4541 / AISI321)

Type J (Fe-CuNi)

Class	Temperature range	Tolerance
1	-40 °C .. +375 °C	± 1.5 °C
	+375 °C .. +750 °C	± 0.0040 x t
2	-40 °C .. +333 °C	± 2.5 °C
	+333 °C .. +750 °C	± 0.0075 x t

Type K (NiCr-Ni), Type N (NiCrSi-NiSi)

Class	Temperature range	Tolerance
1	-40 °C .. +375 °C	± 1.5 °C
	+375 °C .. +1000 °C	± 0.0040 x t
2	-40 °C .. +333 °C	± 2.5 °C
	+333 °C .. +1200 °C	± 0.0075 x t

Insulation types of connection cable

JJ insulation

Conductor: PVC
Sheath: PVC

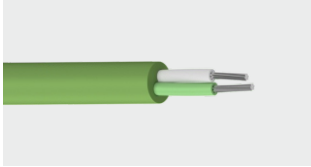

TSL insulation

Conductor: Teflon® FEP
Sheath: Silicone

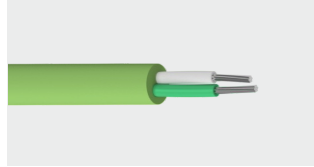

TCuT insulation

Conductor: Teflon® FEP
Screen: Copper braid
Sheath: Teflon® FEP



TT insulation

Conductor: Teflon® PFA
Sheath: Teflon® PFA

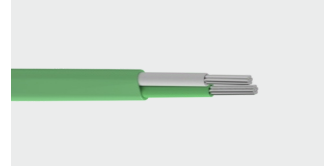

GLP insulation

Conductor: Fiberglass
Sheath: Stainless steel braid



GLGLP insulation

Conductor: Fiberglass
Sheath: Fiberglass
Braid: Stainless steel braid



Available measuring range

Measuring range	Insulation type	
-10 .. +105°C	JJ	PVC
-50 .. +180°C	TSL	silicone
-50 .. +205°C	TCuT	teflon® FEP
-50 .. +260°C	TT	teflon® PFA
-50 .. +400°C	GLP, GLGLP	fiberglass

Non-standard sensor versions

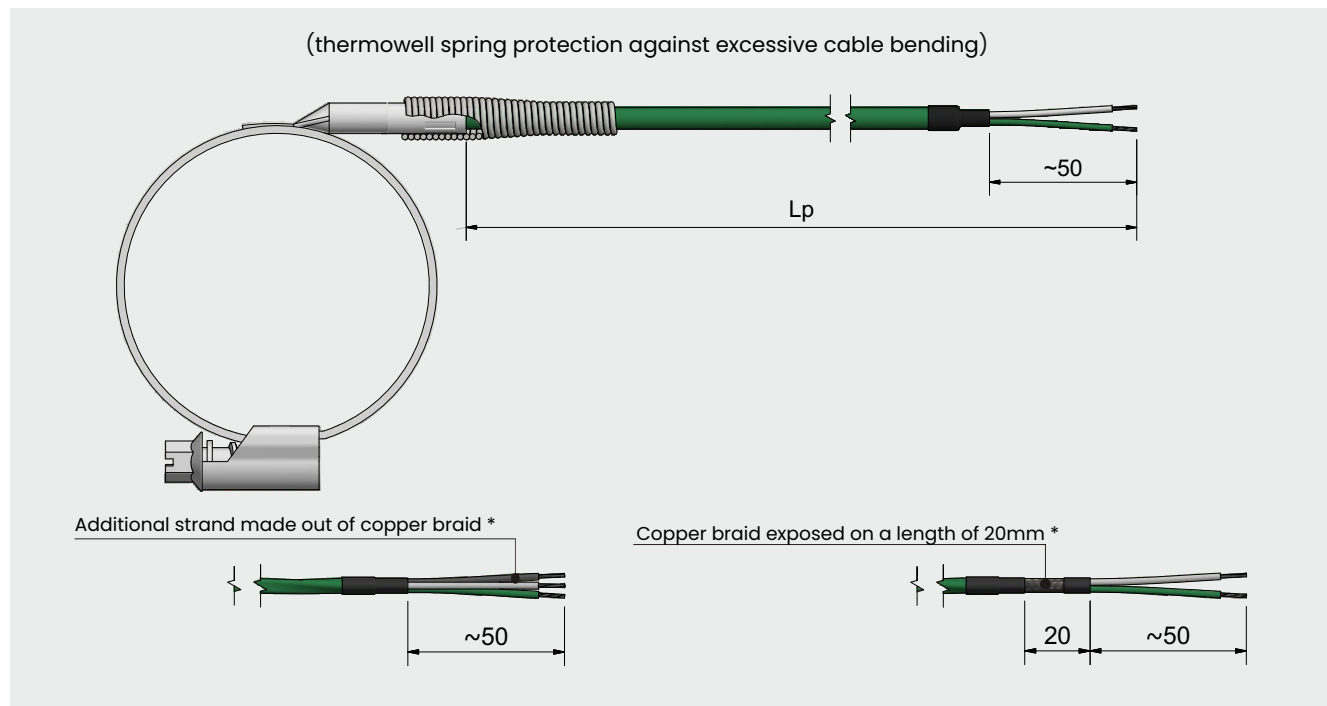

* Available only for TCuT cable insulation

Connectors (optional)

Sensors with connection cable can be equipped with connector.

Available options:

Connector S-010-(thermocouple type)-W

Miniature plug, 2-pin.

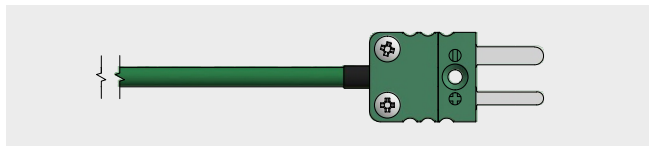

Connector S-010-(thermocouple type)-G

Miniature socket, 2-pin.

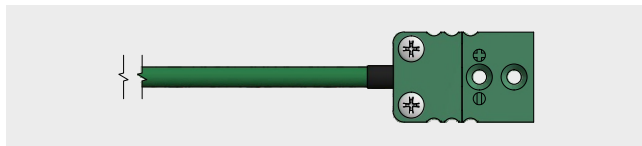

Connector S-013-(thermocouple type)-W

Miniature plug, 3-pin.

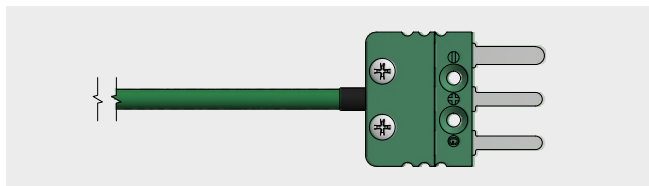

Connector S-013-(thermocouple type)-G

Miniature socket, 3-pin.

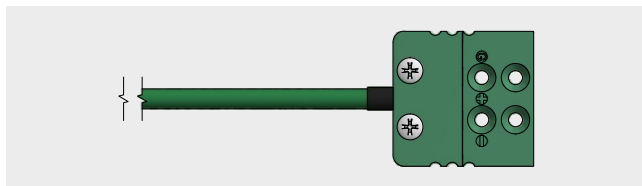

Connector S-020-(thermocouple type)-W

Standard plug, 2-pin.

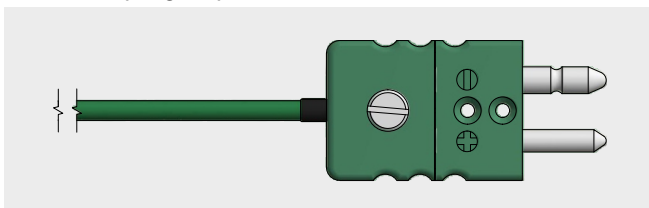

Connector S-020-(thermocouple type)-G

Standard socket, 2-pin.

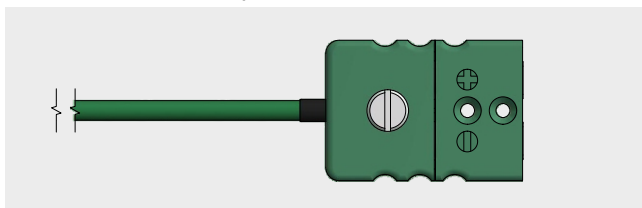

Connector S-023-(thermocouple type)-W

Standard plug, 3-pin.

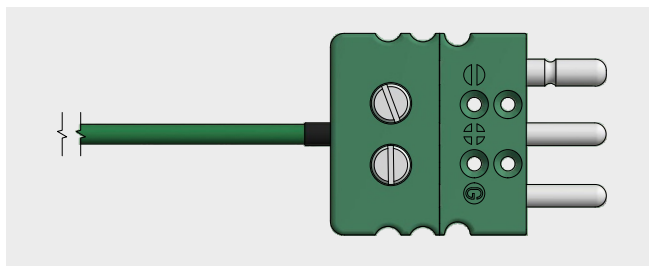

Connector S-023-(thermocouple type)-G

Standard socket, 3-pin.

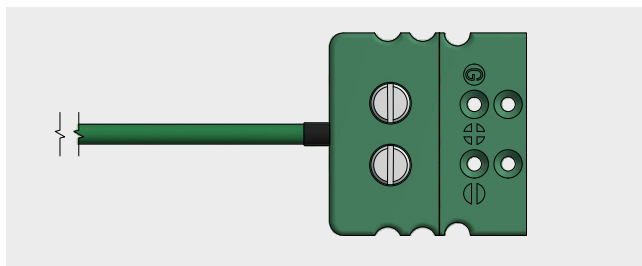

Connector LEMO® FFA

Plug size from 0S to 3S. 2-, 3-, 4-, 6-pin.



Connector LEMO® PCA

Plug size from 0S to 3S. 2-, 3-, 4-, 6-pin.

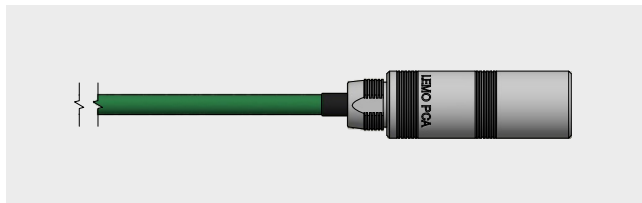

Ordering code

TTE50244S - - - - - -

1	<input type="text"/>	Thermocouple type			
		J	Type J (Fe-CuNi)		
		K	Type K (NiCr-Ni)		
		xxx	other, please specify		
2	<input type="text"/>	Pipeline diameter ØD			
		100	Ø100 mm		
		150	Ø150 mm		
		200	Ø200 mm		
xxx	other, please specify				
3	<input type="text"/>	Connecting cable length Lp			
		1000	1000 mm		
		2500	2500 mm		
xxx	other, please specify				
4	<input type="text"/>	Tolerance class			
		1	Class 1 according to PN-EN 60584-2		
		2	Class 2 according to PN-EN 60584-2		
5	<input type="text"/>	Connecting cable type		Temperature range of sensor	
		JJ	PVC / PVC	-10 .. +105°C	
		TSL	Teflon® FEP / Silicone	-50 .. +180°C	
		TCuT	Teflon® FEP / Cu braid / Teflon® FEP	-50 .. +205°C	
		TT	Teflon® PFA / Teflon® PFA	-50 .. +260°C	
		GLP	Fiberglass / Stainless steel	-50 .. +400°C	
GLGLP	Fiberglass / Fiberglass / Stainless steel	-50 .. +400°C			
6	<input type="text"/>	Connector (optional)			
			without connector, free end conductors of connection cable		
		S-010-K-W	Miniature plug, 2-pin, type K		
		FFA.IS	Connector LEMO® FFA size IS		
		xxx	other, please specify		

Example

TTE50244S-K-150-2000-1-TSL

TC sensor type K, hose-clip match to Ø150 mm, connection cable length Lp=2000 mm, tolerance class 1, single conductors in teflon insulation, sheath in silicone insulation.

TTE50244S-J-100-2500-2-TT-FFA.IS

TC sensor type J, hose-clip match to Ø100 mm, connection cable length Lp=2500 mm, tolerance class 2, single conductors in teflon insulation, sheath in teflon insulation, connection cable equipped with LEMO® FFA plug size IS.