

Applications

- Temperature measurement of pipelines and other cylindrical elements
- General industrial services

Features

- Single or double RTD
- Connection line 2-, 3-, 4-wire
- Single or double RTD:
Pt100, Pt500, Pt1000 (IEC751),
Ni100, Ni500, Ni1000 (DIN43760),
Cu50, Cu100 (GOST 6651-2009)
- Non-standard sensor versions available upon customer's request:
 - cable type according to client's specification
 - thermowell spring protection against excessive cable bending

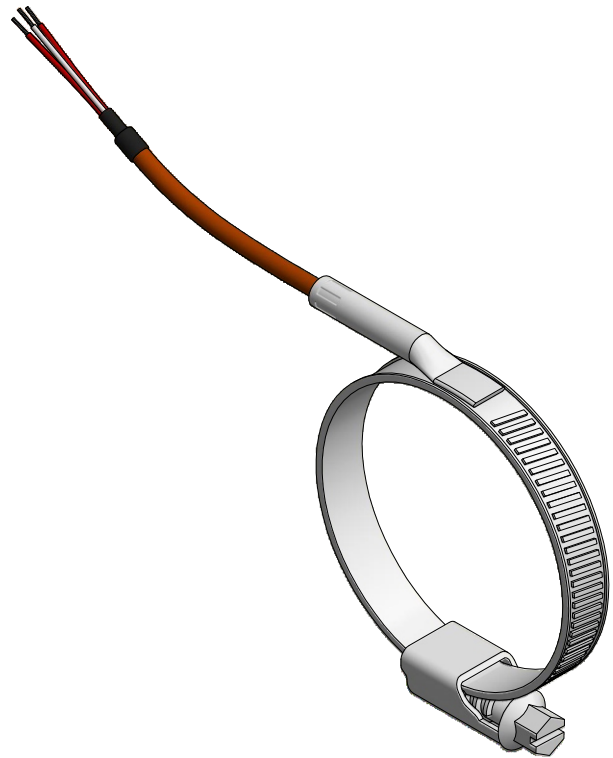

TOPE50244S
TSL cable insulation
(teflon®FEP/silicone)

Resistance thermometers TOPE50244S are designed for assembling directly onto pipelines or other cylindrical elements.

Hose-clip allows to mount sensor on pipeline. Sensors designed for pipeline diameter greater than $\varnothing 100$ mm are equipped with two or more hose-clips.

TOPE50244 consists of thermometric resistor, protection tube made out of stainless steel, hose-clip and connection cable.

Number of sensors, accuracy, cable length and insulation can be selected individually for the respective application.

Temperature transmitter (Option)

There is possibility of using standard temperature transmitter(4÷20mA, 0÷10V) or temperature transmitter with HART®, Profibus® PA, Foundation Fieldbus communication protocol, mounted inside electrical control cabinet.

ATEX, IECEx, EAC Ex versions

Intrinsically safe designs are available for applications in hazardous areas. These models are provided with certificate for „intrinsically safe“ type of protection according to Directive 2014/34/UE (ATEX), IECEx scheme and EAC Ex TR-CU 012/2011 (Eurasian Economic Union).

Intrinsically safe (Exi) XI-TOPE50244S

Designs

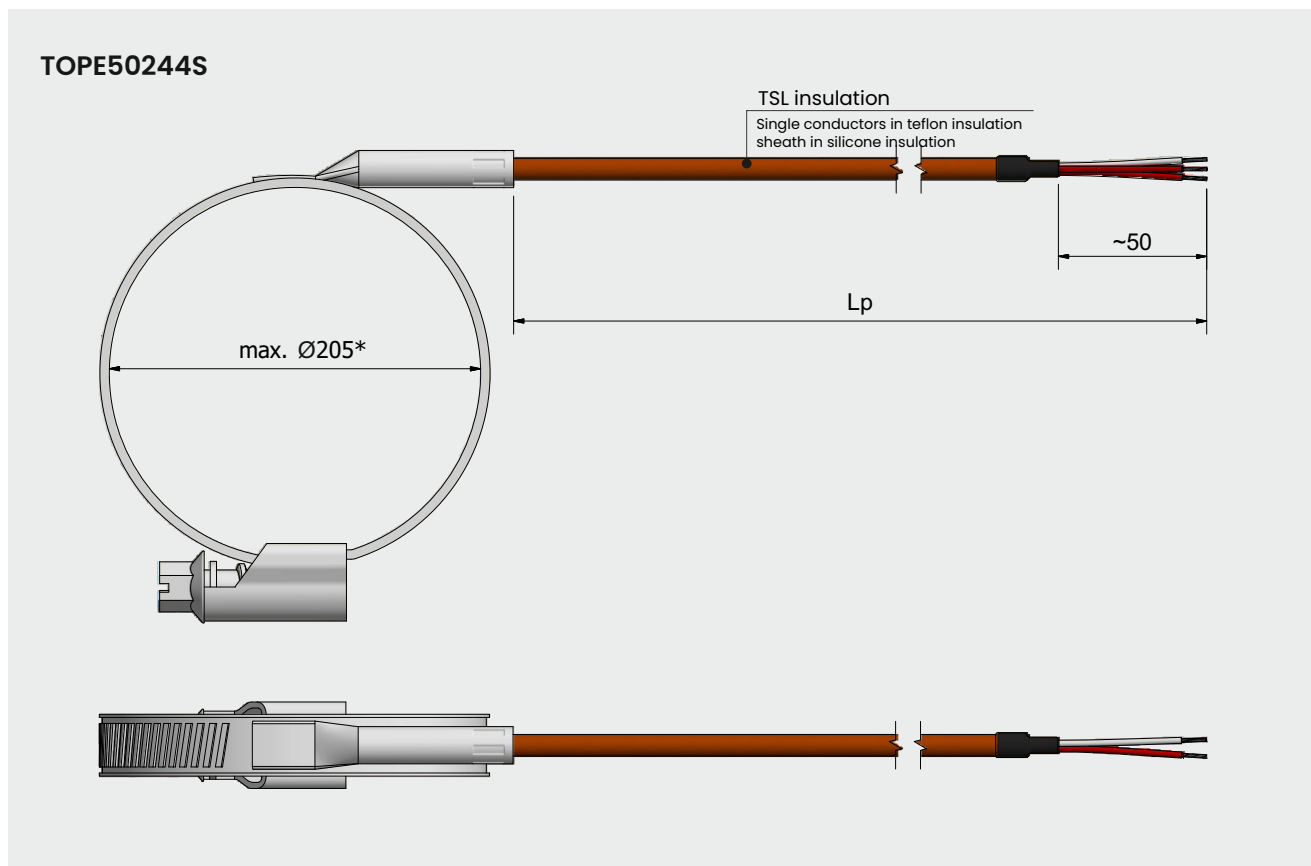

* Diameter > Ø205 are available for special client's request

Measuring range

from -50°C to +400°C (depends on cable insulation type)

Sensing element

Single or double

Pt100, Pt500, Pt1000	(IEC 751, $\alpha=0.00385$)
Ni100, Ni500, Ni1000	(DIN43760, $\alpha=0.00618$)
Cu50, Cu100	(GOST 6651-94, $\alpha=0.00426$)

Tolerance class

Platinum	Class A ($\pm 0.15^\circ\text{C}$ in temp. 0°C)
	Class B ($\pm 0.30^\circ\text{C}$ in temp. 0°C)
Nickel	($\pm 0.40^\circ\text{C}$ in temp. 0°C)
Copper	($\pm 0.30^\circ\text{C}$ in temp. 0°C)

PN-EN 60751 standard defines the formulas for calculating acceptable measure tolerance.

Class of tolerance	Tolerance °C
A	$\pm 0.15 + (0.002 \times t)$
B	$\pm 0.30 + (0.005 \times t)$

Electrical parameters

Measuring current	nom. 0,1 mA to 1 mA
Isolation resistance	> 10 G Ω (test 500 VDC)

Housing material

Stainless steel 1H18N9T (1.4541 / AISI321)

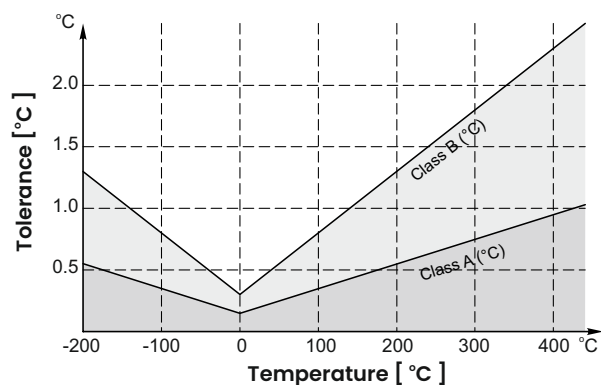

Insulation types of connection cable

JJ insulation

Conductor: PVC
Sheath: PVC

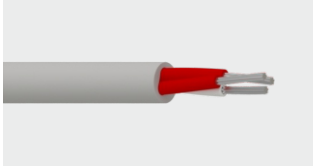

SLSL insulation

Conductor: Silikon
Sheath: Silikon

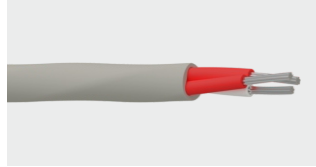

TSL insulation

Conductor: Teflon® FEP
Sheath: Silicone

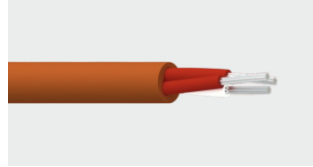

TPSL insulation

Conductor: Teflon® FEP
Screen: Copper braid
Sheath: Silicone



TT insulation

Conductor: Teflon® PFA
Sheath: Teflon® PFA

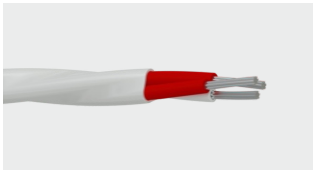

TP insulation

Conductor: Teflon® PFA
Sheath: Stainless steel braid



TCuT insulation

Conductor: Teflon® PFA
Screen: Copper braid
Sheath: Teflon® PFA



GLGLP insulation

Conductor: Fiberglass
Screen: Fiberglass
Sheath: Stainless steel braid

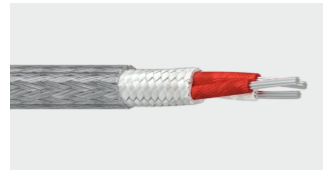

Available measuring range

Measuring range	Insulation type	
-10 .. +105°C	JJ	PVC
-50 .. +180°C	SLSL, TSL, TPSL	silicone
-50 .. +260°C	TT, TP, TCuT	teflon® PFA
-50 .. +400°C	GLGLP	fiberglass

Non-standard sensor versions

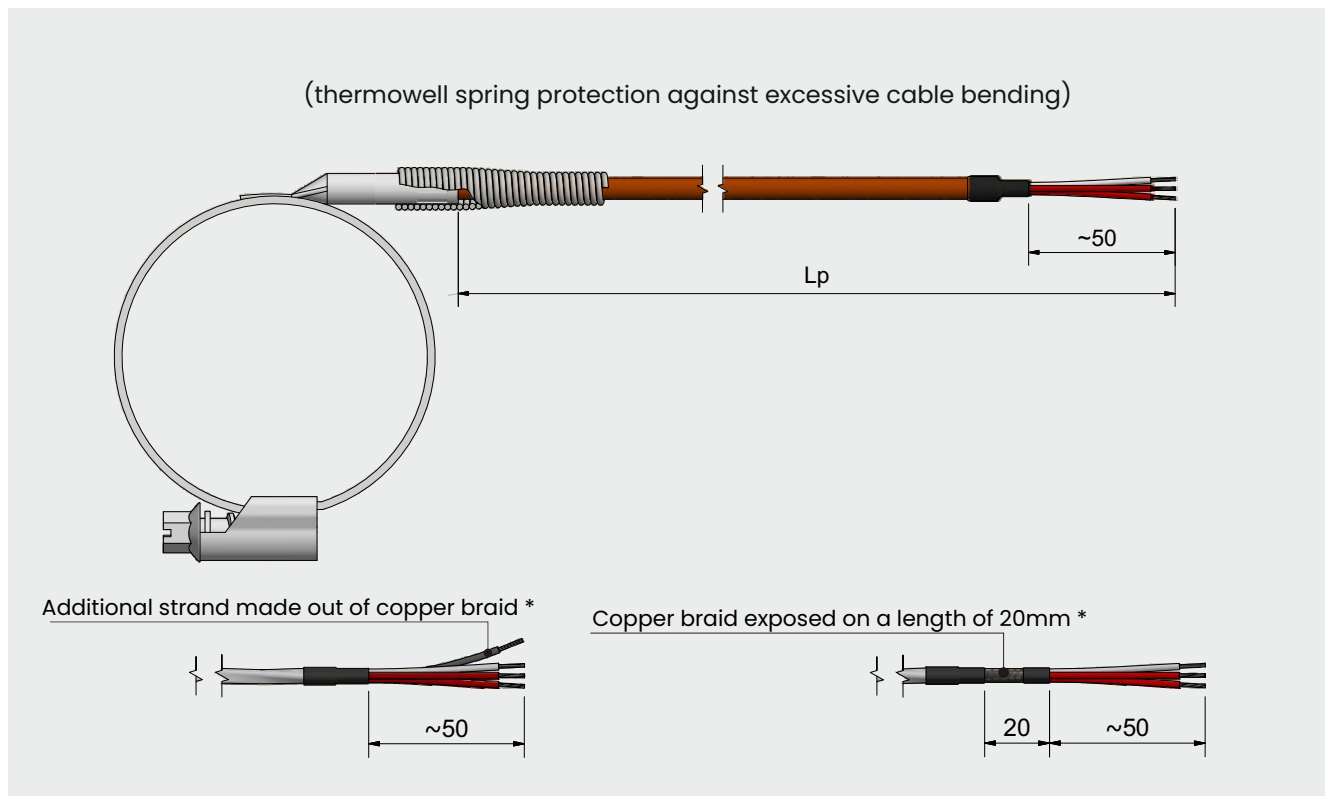

* Available only for TCuT and TPSL cable insulation

Connectors (optional)

Sensors with connection cable can be equipped with connector.

Available options:

Connector S-010-Cu-W

Miniature plug, 2-pin.

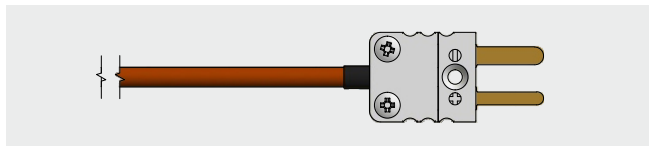

Connector S-010-Cu-G

Miniature socket, 2-pin.

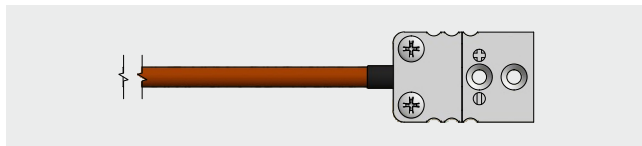

Connector S-013-Cu-W

Miniature plug, 3-pin.

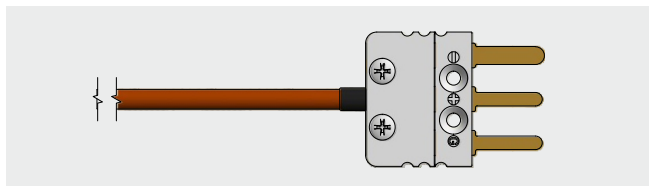

Connector S-013-Cu-G

Miniature socket, 3-pin.

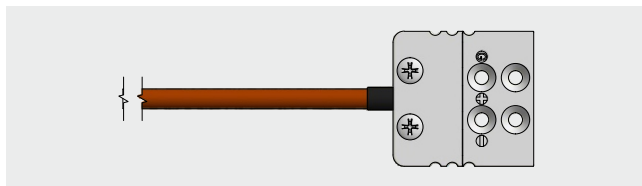

Connector S-020-Cu-W

Standard plug, 2-pin.

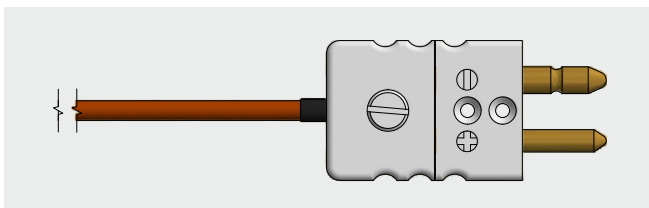

Connector S-020-Cu-G

Standard socket, 2-pin.

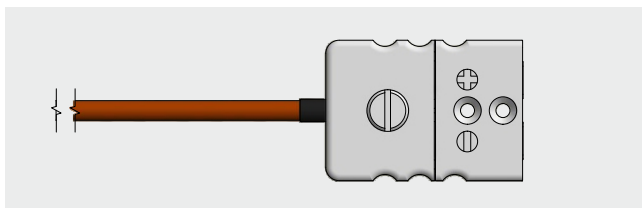

Connector S-023-Cu-W

Standard plug, 3-pin.

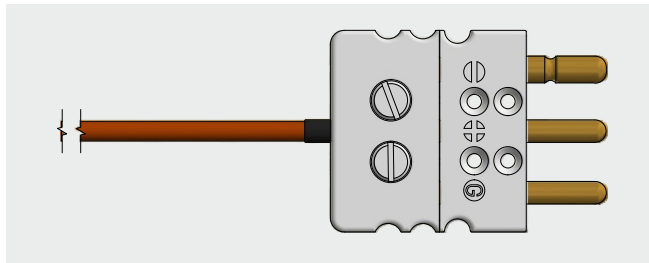

Connector S-023-Cu-G

Standard socket, 3-pin.

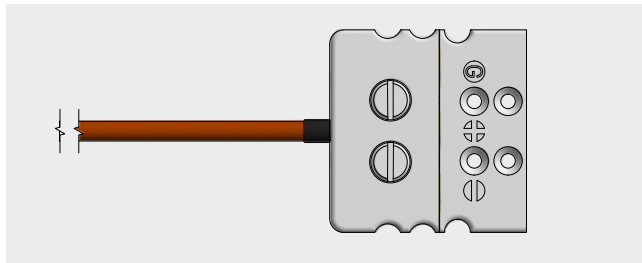

Connector LEMO® FFA

Plug size from 0S to 3S. 2-, 3-, 4-, 6-pin.

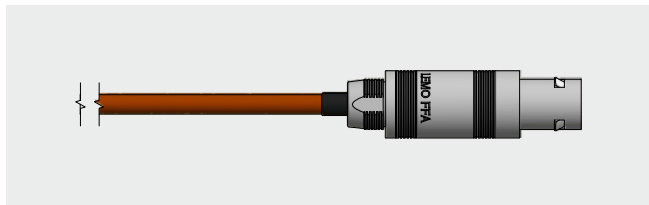

Connector LEMO® PCA

Plug size from 0S to 3S. 2-, 3-, 4-, 6-pin.

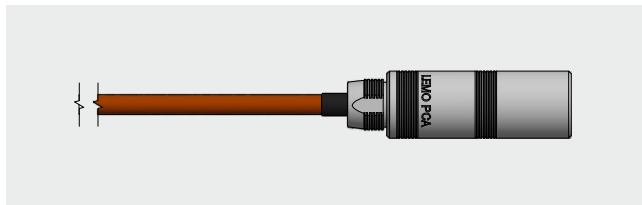

Hirschmann M12 series

4-pin.

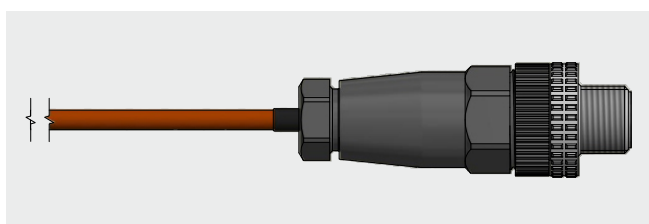

Ordering code

TOPE50244S - - - - - - -

1	<input type="text"/>	Type of sensing element	
		1xPt100	Single Pt100 IEC 751, $\alpha=0.00385$
		2xPt100	Double Pt100 IEC 751, $\alpha=0.00385$
		1xNi100	Single Ni100 DIN43760, $\alpha=0.00618$
		2xNi100	Double Ni100 DIN43760, $\alpha=0.00618$
	xxx	other, please specify	
2	<input type="text"/>	Pipeline diameter ØD	
		100	Ø100 mm
		150	Ø150 mm
		200	Ø200 mm
	xxx	other, please specify	
3	<input type="text"/>	Connecting cable length Lp	
		1000	1000 mm
		2500	2500 mm
	xxx	other, please specify	
4	<input type="text"/>	Tolerance class	
		A	Class A wg PN-EN 60751 / IEC 751 (available only for platinum sensing elements)
		B	Class B wg PN-EN 60751 / IEC 751 / DIN43760 / GOST 6651-94
5	<input type="text"/>	Measuring circuit	
		2	2-wire (available only in B tolerance class)
		3	3-wire
		4	4-wire
6	<input type="text"/>	Connecting cable type	
		JJ	PVC / PVC -10 .. +105°C
		SLSL	Silikon / Silicone -50 .. +180°C
		TSL	Teflon® FEP / Silicone -50 .. +180°C
		TPSL	Teflon® FEP / Cu braid / Silicone -50 .. +180°C
		TT	Teflon® PFA / Teflon® PFA -50 .. +260°C
		TP	Teflon® PFA / Stainless steel -50 .. +260°C
		TCuT	Teflon® PFA / Cu braid / Teflon® PFA -50 .. +260°C
GLGLP	Fiberglass / Fiber glass / Stainless steel -50 .. +400°C		
7	<input type="text"/>	Connector (optional)	
			without connector, free end conductors of connection cable
		S-013-Cu-W	Miniature plug, 3-pin
		FFA.1S	Connector LEMO® FFA size 1S
	xxx	other, please specify	

Example

TOPE50244S-1xPt100-150-2000-A-3-TSL

RTD sensor 1xPt100, hose-clip match to Ø150 mm, connection cable length Lp=2000 mm, A tolerance class, 3-wire measuring circuit, single conductors in teflon insulation, sheath in silicone insulation.

TOPE50244S-1xPt100-100-2500-B-2-TT-FFA.1S

RTD sensor 1xPt100, hose-clip match to Ø100 mm, connection cable length Lp=2500 mm, B tolerance class, 2-wire measuring circuit, single conductors in teflon insulation, sheath in teflon insulation, connection cable equipped with LEMO® FFA plug size 1S.