

PERFORMANCE
MADE
SMARTER

Product manual

4114

Universal transmitter



TEMPERATURE | I.S. INTERFACES | COMMUNICATION INTERFACES | MULTIFUNCTIONAL | ISOLATION | DISPLAY

No. 4114V106-UK
From serial no.: 192103901

PR
electronics

6 Product Pillars

to meet your every need

Individually outstanding, unrivalled in combination

With our innovative, patented technologies, we make signal conditioning smarter and simpler. Our portfolio is composed of six product areas, where we offer a wide range of analog and digital devices covering over a thousand applications in industrial and factory automation. All our products comply with or surpass the highest industry standards, ensuring reliability in even the harshest of environments and have a 5-year warranty for greater peace of mind.



Temperature

Our range of temperature transmitters and sensors provides the highest level of signal integrity from the measurement point to your control system. You can convert industrial process temperature signals to analog, bus or digital communications using a highly reliable point-to-point solution with a fast response time, automatic self-calibration, sensor error detection, low drift, and top EMC performance in any environment.



I.S. Interface

We deliver the safest signals by validating our products against the toughest safety standards. Through our commitment to innovation, we have made pioneering achievements in developing I.S. interfaces with SIL 2 Full Assessment that are both efficient and cost-effective. Our comprehensive range of analog and digital intrinsically safe isolation barriers offers multifunctional inputs and outputs, making PR an easy-to-implement site standard. Our backplanes further simplify large installations and provide seamless integration to standard DCS systems.



Communication

We provide inexpensive, easy-to-use, future-ready communication interfaces that can access your PR installed base of products. All the interfaces are detachable, have a built-in display for readout of process values and diagnostics, and can be configured via push-buttons. Product specific functionality includes communication via Modbus and Bluetooth and remote access using our PR Process Supervisor (PPS) application, available for iOS and Android.



Multifunction

Our unique range of single devices covering multiple applications is easily deployable as your site standard. Having one variant that applies to a broad range of applications can reduce your installation time and training, and greatly simplify spare parts management at your facilities. Our devices are designed for long-term signal accuracy, low power consumption, immunity to electrical noise and simple programming.



Isolation

Our compact, fast, high-quality 6 mm isolators are based on microprocessor technology to provide exceptional performance and EMC-immunity for dedicated applications at a very low total cost of ownership. They can be stacked both vertically and horizontally with no air gap separation between units required.



Display

Our display range is characterized by its flexibility and stability. The devices meet nearly every demand for display readout of process signals and have universal input and power supply capabilities. They provide a real-time measurement of your process value no matter the industry and are engineered to provide a user-friendly and reliable relay of information, even in demanding environments.

Universal transmitter 4114

Table of contents

Warning	4
Symbol identification	4
Safety instructions	4
How to demount system 4000	6
When front LED lights red / display shows AO.ER	6
Application	7
Technical characteristics	7
Mounting / installation / programming	7
Applications	8
PR 4500 display / programming front	9
Mounting / demounting the PR 4500 communication interfaces	9
Order	10
Accessories	10
Electrical specifications	10
Visualisation in the PR 4500 of sensor error detection and input signal outside range	14
Sensor error detection limits	14
Error indications	15
Connections	16
Block diagram	17
Configuration / operating the function keys	18
Routing diagram	20
Routing diagram, advanced settings (ADV.SET)	22
Help text overview	23
Document history	24

Warning



GENERAL

This device is designed for connection to hazardous electric voltages. Ignoring this warning can result in severe personal injury or mechanical damage.

To avoid the risk of electric shock and fire, the safety instructions of this guide must be observed and the guidelines followed. The specifications must not be exceeded, and the device must only be applied as described in the following.

Prior to the commissioning of the device, this installation guide must be examined carefully.

Only qualified personnel (technicians) should install this device. If the equipment is used in a manner not specified by the manufacturer, the protection provided by the equipment may be impaired.



**HAZARD-
OUS
VOLTAGE**

Warning

Until the device is fixed, do not connect hazardous voltages to the device. The following operations should only be carried out on a disconnected device and under ESD safe conditions:

General mounting, connection and disconnection of wires.

Troubleshooting the device.



CAUTION

Repair of the device and replacement of circuit breakers must be done by PR electronics A/S only.

Warning



**INSTAL-
LATION**

Do not open the front plate of the device as this will cause damage to the connector for the display / programming front PR 4500.

This device contains no DIP-switches or jumpers.

SYSTEM 4000 must be mounted on a DIN rail according to DIN EN 60715.

Symbol identification



Triangle with an exclamation mark: Warning / demand. Potentially lethal situations. Read the manual before installation and commissioning of the device in order to avoid incidents that could lead to personal injury or mechanical damage.



The CE mark proves the compliance of the device with the essential requirements of the directives.



The double insulation symbol shows that the device is protected by double or reinforced insulation.

Safety instructions

Definitions

Hazardous voltages have been defined as the ranges: 75 to 1500 Volt DC, and 50 to 1000 Volt AC.

Technicians are qualified persons educated or trained to mount, operate, and also trouble-shoot technically correct and in accordance with safety regulations.

Operators, being familiar with the contents of this manual, adjust and operate the knobs or potentiometers during normal operation.

Receipt and unpacking

Unpack the device without damaging it and check whether the device type corresponds to the one ordered. The packing should always follow the device until this has been permanently mounted.

Environment

Avoid direct sun light, dust, high temperatures, mechanical vibrations and shock, and rain and heavy moisture. If necessary, heating in excess of the stated limits for ambient temperatures should be avoided by way of ventilation.

The device must be installed in pollution degree 2 or better.

The device is designed to be safe at least under an altitude up to 2 000 m.

The device is designed for indoor use.

Mounting

Only technicians who are familiar with the technical terms, warnings, and instructions in the manual and who are able to follow these, should connect the device. Should there be any doubt as to the correct handling of the device, please contact your local distributor or, alternatively,

PR electronics A/S
www.prelectronics.com

Mounting and connection of the device should comply with national legislation for mounting of electric materials, i.e. wire cross section, protective fuse, and location.

Stranded wire should be installed with an insulation stripping length of 5 mm or via a suitable insulated terminal such as a bootlace ferrule.

Descriptions of input / output and supply connections are shown in the block diagram and side label.

The following apply to fixed hazardous voltages-connected devices:

The max. size of the protective fuse is 10 A and, together with a power switch, it should be easily accessible and close to the device. The power switch should be marked with a label indicating that it will switch off the voltage to the device.

Year of manufacture can be taken from the first two digits in the serial number.

UL installation requirements

Use 60/75°C copper conductors only

For use only in pollution degree 2 or better

Max. ambient temperature 60°C

Max. wire size. AWG 26-14

UL file number E231911

Calibration and adjustment

During calibration and adjustment, the measuring and connection of external voltages must be carried out according to the specifications of this manual. The technician must use tools and instruments that are safe to use.

Normal operation

Operators are only allowed to adjust and operate devices that are safely fixed in panels, etc., thus avoiding the danger of personal injury and damage. This means there is no electrical shock hazard, and the device is easily accessible.

Cleaning

When disconnected, the device may be cleaned with a cloth moistened with distilled water.

Liability

To the extent the instructions in this manual are not strictly observed, the customer cannot advance a demand against PR electronics A/S that would otherwise exist according to the concluded sales agreement.

How to demount system 4000

First, remember to demount the connectors with hazardous voltages.

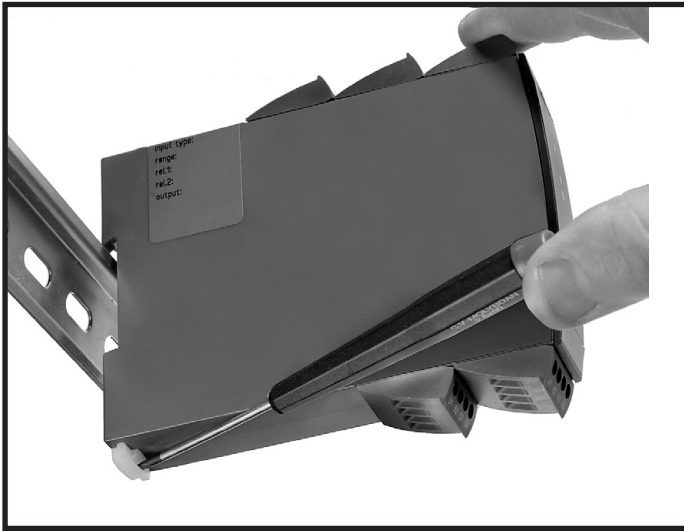

Picture 1:

The device is detached from the DIN rail by moving the bottom lock down.

When front LED lights red / display shows AO.ER

PR 4114 is designed as a SIL 2 device with a high safety level. Therefore, a continuous measurement of the outgoing current is carried out on a 4...20 mA and 20...4 mA output signal. If the current output signal is different from the internal calculated output value or the current output is 0 (due to e.g. an open circuit breakage), an error mode switches on the red front LED. This function is not a default option but must be actively selected via the programming menu (S4-20 & S20-4). The error mode can only be reset by switching off and then switching on the supply voltage to the device.

Universal transmitter

4114

- Input for RTD, TC, Ohm, potentiometer, mA and V
- 2-wire supply > 16 V
- FM-approved for installation in Div. 2
- Output for current and voltage
- Universal AC or DC supply

Application

- Linearized, electronic temperature measurement with RTD or TC sensor.
- Conversion of linear resistance variation to a standard analog current / voltage signal, i.e. from solenoids and butterfly valves or linear movements with attached potentiometer.
- Power supply and signal isolator for 2-wire transmitters.
- Process control with standard analog output.
- Galvanic separation of analog signals and measurement of floating signals.
- The 4114 is designed according to strict safety requirements and is thus suitable for application in SIL 2 installations.
- Suitable for the use in systems up to Performance Level "d" according to ISO-13849.

Technical characteristics

- When 4114 is used in combination with the PR 4500 display / programming units, all operational parameters can be modified to suit any application. As the 4114 is designed with electronic hardware switches, it is not necessary to open the device for setting of DIP-switches.
- A green / red front LED indicates normal operation and malfunction.
- Continuous check of vital stored data for safety reasons.
- 3-port 2.3 kVAC galvanic isolation.

Mounting / installation / programming

- Very low power consumption means units can be mounted side by side without an air gap - even at 60°C ambient temperature.
- Configuration, monitoring, 2-point process calibration and more are accomplished using PR's 4500 detachable displays.
- All programming can be password-protected.

Applications

Input signals:

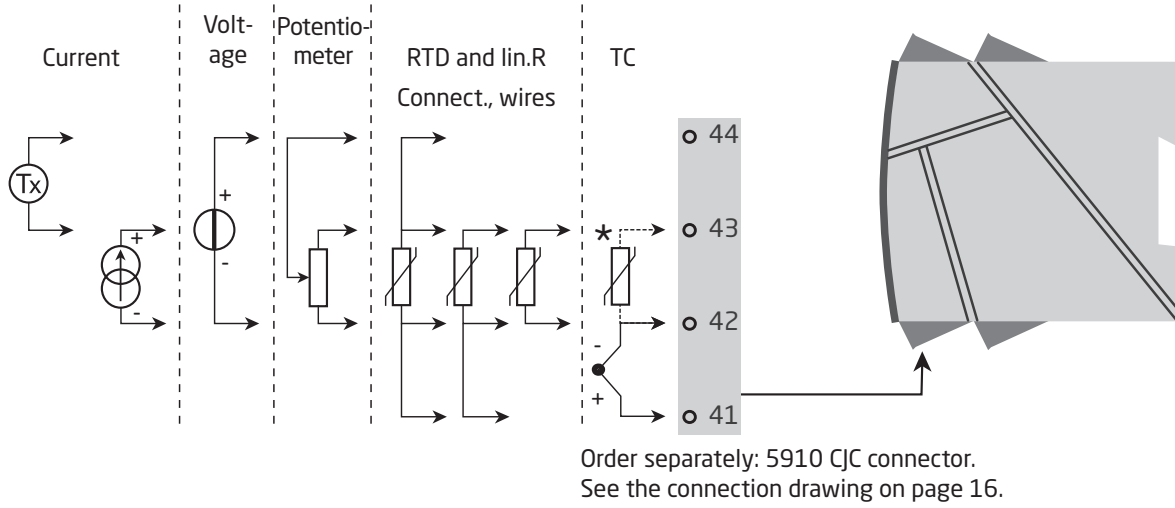

Output signals:

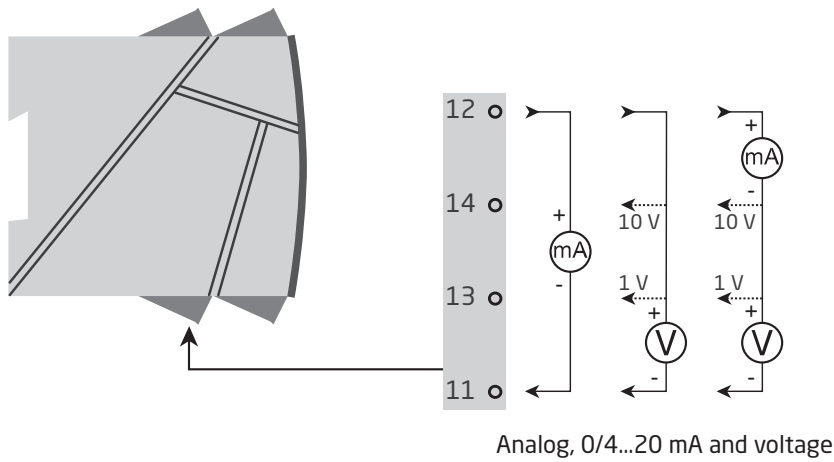

Supply:

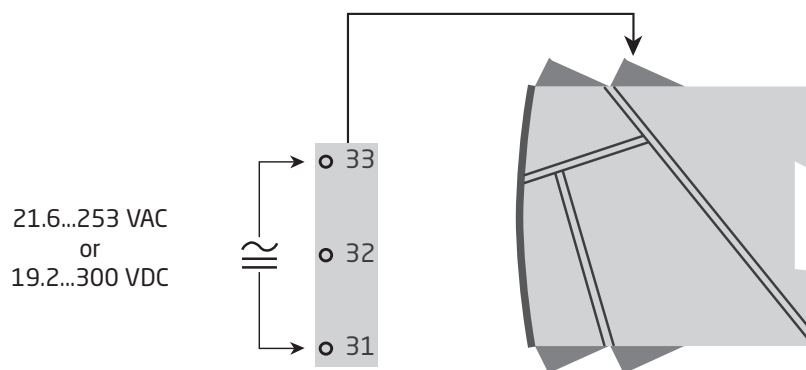

PR 4500 display / programming front



Functionality

The simple and easily understandable menu structure and the explanatory help texts guide you effortlessly and automatically through the configuration steps, thus making the product very easy to use. Functions and configuration options are described in the section "Configuration / operating the function keys".

Application

- Communications interface for modification of operational parameters in 4114.
- Can be moved from one 4114 device to another and download the configuration of the first unit to subsequent units.
- Fixed display for readout of process data and status.



Technical characteristics

- LCD display with 4 lines:
 - Line 1 (H=5.57 mm) shows the input signal.
 - Line 2 (H=3.33 mm) shows the selected engineering unit.
 - Line 3 (H=3.33 mm) shows analog output or TAG no.
 - Line 4 shows status for communication.
- Programming access can be blocked by assigning a password. The password is saved in the device in order to ensure a high degree of protection against unauthorized modifications to the configuration.

Mounting / demounting the PR 4500 communication interfaces

- 1: Insert the tabs of the PR 4500 into the slots at the top of the device.
- 2: Hinge the PR 4500 down until it snaps into place.

Demounting of the PR 4500 communication interfaces

- 3: Push the release button on the bottom of the PR 4500 and hinge the PR 4500 out and up.
- 4: With the PR 4500 hinged up, remove from the slots at the top of the device.

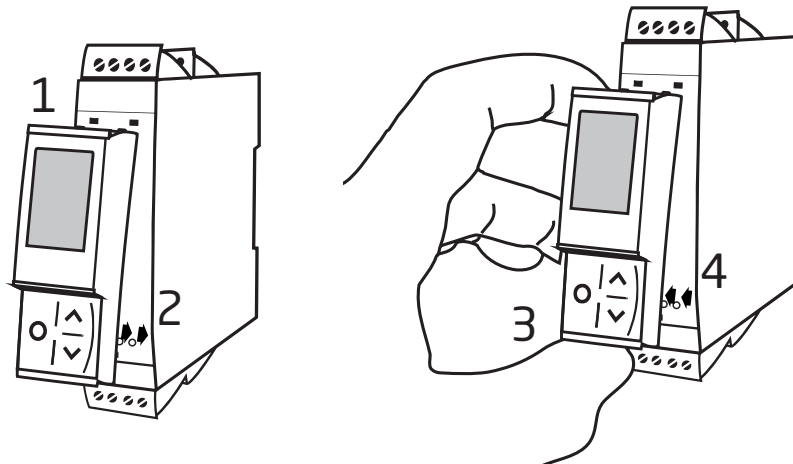

Order

4114 = Universal transmitter

Accessories

4510 = Display / programming front

4511 = Modbus communication enabler

4512 = Bluetooth communication enabler

5910 = CJC connector

Electrical specifications

Environmental conditions

Operating temperature	-20°C to +60°C
Storage temperature	-20°C to +85°C
Calibration temperature.	20...28°C
Relative humidity	< 95% RH (non-cond.)
Protection degree	IP20
Installation in pollution degree 2 & measurement / overvoltage category II.	

Mechanical specifications

Dimensions (HxWxD)	109 x 23.5 x 104 mm
Dimensions (HxWxD) w/ 4501 / 451x	109 x 23.5 x 116 / 131 mm
Weight approx.	155 g
DIN rail type.	DIN EN 60715 - 35 mm
Wire size.	0.13...2.08 mm ² / AWG 26...14 stranded wire
Screw terminal torque.	0.5 Nm
Vibration.	IEC 60068-2-6
2...13.2 Hz	±1 mm
13.2...100 Hz.	±0.7 g

Common electrical specifications

Supply voltage, universal.	21.6...253 VAC, 50...60 Hz or 19.2...300 VDC
Fuse	400 mA SB / 250 VAC
Max. required power.	≤ 2.0 W
Max. power dissipation	≤ 2.0 W
Isolation voltage - test	2.3 kVAC
Isolation voltage - working.	250 VAC (reinforced) / 500 VAC (basic)
Programming	PR 4500
Signal dynamics, input / output	24 bit / 16 bit
Signal / noise ratio.	> 60 dB (0...100 kHz)
Response time (0...90%, 100...10%):	
Temperature input.	≤ 1 s
mA / V input	≤ 400 ms

Auxiliary supplies

2-wire supply (terminal 44...43).	25...16 VDC / 0...20 mA
---	-------------------------

Accuracy, the greater of general and basic values:

General values		
Input type	Absolute accuracy	Temperature coefficient
All	$\leq \pm 0.1\%$ of span	$\leq \pm 0.01\%$ of span / °C

Basic values		
Type	Basic accuracy	Temperature coefficient
mA	$\leq \pm 4 \mu\text{A}$	$\leq \pm 0.4 \mu\text{A} / ^\circ\text{C}$
Volt	$\leq \pm 20 \mu\text{V}$	$\leq \pm 2 \mu\text{V} / ^\circ\text{C}$
Pt100	$\leq \pm 0.2^\circ\text{C}$	$\leq \pm 0.01^\circ\text{C} / ^\circ\text{C}$
Linear resistance	$\leq \pm 0.1 \Omega$	$\leq \pm 0.01 \Omega / ^\circ\text{C}$
Potentiometer	$\leq \pm 0.1 \Omega$	$\leq \pm 0.01 \Omega / ^\circ\text{C}$
TC type: E, J, K, L, N, T, U	$\leq \pm 1^\circ\text{C}$	$\leq \pm 0.05^\circ\text{C} / ^\circ\text{C}$
TC type: R, S, W3, W5, LR	$\leq \pm 2^\circ\text{C}$	$\leq \pm 0.2^\circ\text{C} / ^\circ\text{C}$
TC type: B 85...200°C	$\leq \pm 4^\circ\text{C}$	$\leq \pm 0.4^\circ\text{C} / ^\circ\text{C}$
TC type: B 200...1820°C	$\leq \pm 2^\circ\text{C}$	$\leq \pm 0.2^\circ\text{C} / ^\circ\text{C}$

EMC - immunity influence.	$< \pm 0.5\%$ of span
Extended EMC immunity: NAMUR NE 21, A criterion, burst	$< \pm 1\%$ of span

Input specifications

RTD, linear resistance and potentiometer input

Input for RTD types:

Pt10, Pt20, Pt50, Pt100, Pt200, Pt250, Pt300, Pt400, Pt500, Pt1000

Ni50, Ni100, Ni120, Ni1000, Cu10, Cu20, Cu50, Cu100

Input type	Min. value	Max. value	Standard
Pt10...Pt1000	-200°C	+850°C	IEC 60751
Ni50...Ni1000	-60°C	+250°C	DIN 43760
Cu10...Cu100	-200°C	+260°C	$\alpha = 0.00427$
Lin. R	0 Ω	10000 Ω	-
Potentiometer	10 Ω	100 k Ω	-

Cable resistance per wire (max.), RTD 50 Ω

Sensor current, RTD Nom. 0.2 mA

Effect of sensor cable resistance (3- / 4-wire), RTD $< 0.002 \Omega / \Omega$

Sensor error detection, RTD Yes

Short circuit detection, RTD $< 15 \Omega$

TC input

Type	Min. value	Max. value	Standard
B	0°C	+1820°C	IEC 60584-1
E	-100°C	+1000°C	IEC 60584-1
J	-100°C	+1200°C	IEC 60584-1
K	-180°C	+1372°C	IEC 60584-1
L	-200°C	+900°C	DIN 43710
N	-180°C	+1300°C	IEC 60584-1
R	-50°C	+1760°C	IEC 60584-1
S	-50°C	+1760°C	IEC 60584-1
T	-200°C	+400°C	IEC 60584-1
U	-200°C	+600°C	DIN 43710
W3	0°C	+2300°C	ASTM E988-90
W5	0°C	+2300°C	ASTM E988-90
LR	-200°C	+800°C	GOST 3044-84

Cold junction compensation (CJC):

via external sensor in connector 5910. 20...28°C $\leq \pm 1^\circ\text{C}$
 -20...20°C / 28...70°C $\leq \pm 2^\circ\text{C}$

via internal CJC sensor $\pm(2.0^\circ\text{C} + 0.4^\circ\text{C} * \Delta t)$

Δt = internal temperature - ambient temperature

Sensor error detection, all TC types. Yes

Sensor error current:

when detecting Nom. 2 μA
 else. 0 μA

Current input

Measurement range 0...23 mA
 Programmable measurement ranges 0...20 and 4...20 mA
 Input resistance Nom. 20 Ω + PTC 50 Ω
 Sensor error detection:
 Loop break 4...20 mA Yes

Voltage input

Measurement range 0...12 VDC
 Programmable measurement ranges 0...1 / 0.2...1 / 0...5 / 1...5 / 0...10 and 2...10 VDC
 Input resistance, nom. 10 M Ω

Output specifications

Current output

Signal range (span) 0...23 mA
 Programmable signal ranges 0...20 / 4...20 / 20...0 and 20...4 mA
 Load (max.) $\leq 800 \Omega$
 Load stability $\leq 0.01\%$ of span / 100 Ω
 Sensor error detection 0 / 3.5 / 23 mA / none
 NAMUR NE 43 Upscale / Downscale 23 mA / 3.5 mA
 Output limitation:
 on 4...20 and 20...4 mA signals 3.8...20.5 mA
 on 0...20 and 20...0 mA signals 0...20.5 mA
 Current limit. $\leq 28 \text{ mA}$

Voltage output

Signal range. 0...10 VDC
 Programmable signal ranges 0...1 / 0.2...1 / 0...10 / 0...5 / 1...5 / 2...10 / 1...0 /
 1...0.2 / 5...0 / 5...1 / 10...0 og 10...2 V
 Load (min.) 500 k Ω

of span = of the currently selected measurement range

Observed authority requirements

EMC	2014/30/EU & UK SI 2016/1091
LVD	2014/35/EU & UK SI 2016/1101
RoHS	2011/65/EU & UK SI 2012/3032
EAC	TR-CU 020/2011

Approvals:

c UL us, UL 508	E231911
FM	3025177
DNV-GL	TAA0000101
EU RO Mutual Recognition Type Approval	MRA000000Z

Functional Safety:

Hardware assessed for use in SIL applications
FMEDA report - www.prelectronics.com

Visualisation in the PR 4500 of sensor error detection and input signal outside range

Sensor error check:		
Device	Configuration	Sensor error detection:
4114	OUT.ERR=NONE.	OFF
	Else:	ON

Outside range readout (IN.LO, IN.HI): If the valid range of the A/D converter or the polynomial is exceeded			
Input	Range	Readout	Limit
VOLT	0...1 V / 0.2...1 V	IN.LO	< -25 mV
		IN.HI	> 1.2 V
	0...10 V / 2...10 V	IN.LO	< -25 mV
		IN.HI	> 12 V
CURR	0...20 mA / 4...20 mA	IN.LO	< -1.05 mA
		IN.HI	> 25.05 mA
LIN.R	0...800 Ω	IN.LO	< 0 Ω
		IN.HI	> 1075 Ω
	0...10 kΩ	IN.LO	< 0 Ω
		IN.HI	< 110 kΩ
POTM	-	IN.LO	< -0.5 %
		IN.HI	> 100.5 %
TEMP	TC / RTD	IN.LO	< temperature range -2°C
		IN.HI	> temperature range +2°C

Display readout below min. / above max. (-1999, 9999):			
Input	Range	Readout	Limit
All	All	-1999	Display readout <-1999
		9999	Display readout >9999

Sensor error detection limits

Sensor error detection (SE.BR, SE.SH):			
Input	Range	Readout	Limit
CURR	Loop break (4..20 mA)	SE.BR	<= 3.6 mA; > = 21 mA
POTM	All, SE.BR on all 3-wire	SE.BR	> ca. 126 kΩ
LIN.R	0...800 Ω	SE.BR	> ca. 875 Ω
	0...10 kΩ	SE.BR	> ca. 11 kΩ
TEMP	TC	SE.BR	> ca. 750 kΩ / (1.25 V)
	RTD, 2-, 3-, and 4-wire No SE.SH for Cuxx, Pt10, Pt20 and Pt50	SE.BR	> ca. 15 kΩ
		SE.SH	< ca. 15 Ω

Error indications

Readout at hardware error		
Error search	Readout	Cause
Test of internal CJC sensor	CJ.ER	CJC sensor defect or temperature outside range
Checksum test of the configuration in FLASH	FL.CO	Error in FLASH
Check measurement of analog output current	AO.ER	1) No load on the current output (only S4...20 / S20...4 mA)
Communications test PR 4500 / 4114	NO.CO	Connection error
Check that input signal matches input configuration	IN.ER	1) Error levels on input
Check that saved configuration in PR 4500 matches device	TY.ER	Configuration is not 4114

<p>All error indications in the display flash once per second. The help text explains the error. If the error is a sensor error, the display backlight flashes as well - this is acknowledged (stopped) by pushing the  button.</p>
<p>1) The error is reset by switching off and then switching on the supply voltage to the device.</p>

Connections

Supply

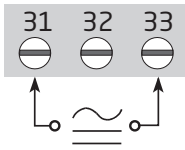

Inputs:

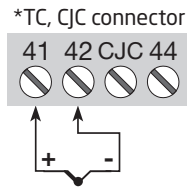
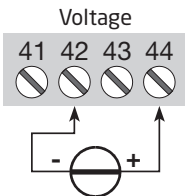
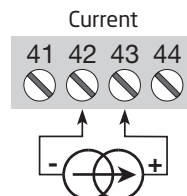
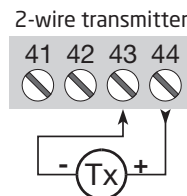
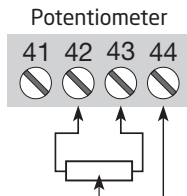
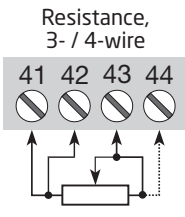
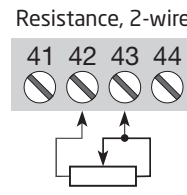
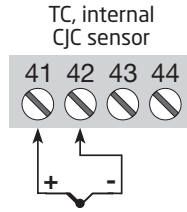
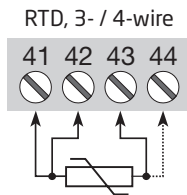
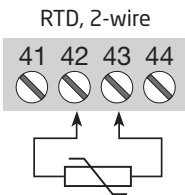

* Order separately; CJC connector 5910

Outputs:

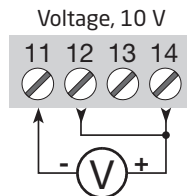
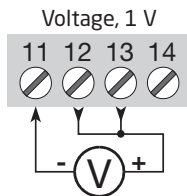
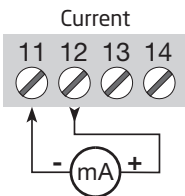

Block diagram

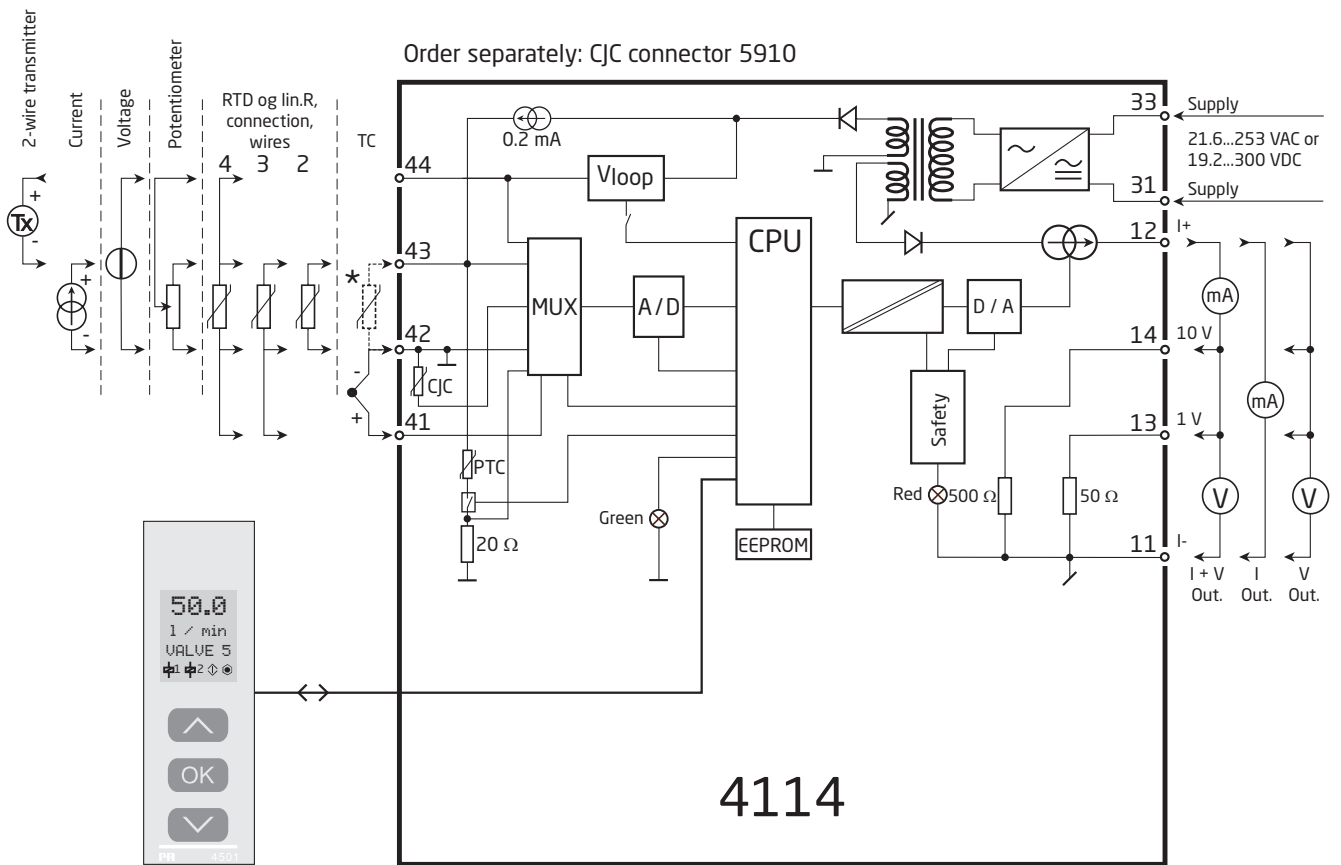

Configuration / operating the function keys

Documentation for routing diagram.

In general

When configuring the 4114, you will be guided through all parameters and you can choose the settings which fit the application. For each menu there is a scrolling help text which is automatically shown in line 3 on the display.

Configuration is carried out by use of the 3 function keys:

- ⏪ will increase the numerical value or choose the next parameter
- ⏩ will decrease the numerical value or choose the previous parameter
- ⏹ will save the chosen value and proceed to the next menu

When configuration is completed, the display will return to the default state 1.0. Pressing and holding ⏹ will return to the previous menu or return to the default state (1.0) without saving the changed values or parameters.

If no key is activated for 1 minute, the display will return to the default state (1.0) without saving the changed values or parameters.

Further explanations

Password protection: Programming access can be blocked by assigning a password. The password is saved in the device in order to ensure a high degree of protection against unauthorized modifications to the configuration.

If the configured password is not known, please contact PR electronics support - www.prelectronics.com/contact.

Signal and sensor error info via display front PR 4500

Sensor error (see limits in the table) is displayed as SE.BR (sensor break) or SE.SH (sensor short). Signals outside the selected range (not sensor error, see table for limits) are displayed as IN.LO indicating low input signal or IN.HI indicating high input signal. The error indication is displayed in line 3 as text and at the same time the backlight flashes. Line 4 of the display is a status line which displays COM (flashing bullet) indicating correct functioning of PR 4500 and arrow up/down which indicates tendency readout of the input signal.

Signal and sensor error indication without display front

Status of the unit can also be read from the red / green LED in the front of the device.

Green flashing LED 13 Hz indicates normal operation.

Green flashing LED 1 Hz indicates sensor error.

Steady red LED indicates internal error.

Advanced functions

The unit gives access to a number of advanced functions which can be reached by answering "Yes" to the point "ADV.SET".

Memory (MEM): In the memory menu you can save the configuration of the device in the PR 4500, and then move the PR 4500 onto another device of the same type and download the configuration in the new device.

Display setup (DISP): Here you can adjust the brightness contrast and the backlight. Setup of TAG numbers with 6 alphanumeric. Selection of functional readout in line 3 of the display - choose between readout of analog output or tag no.

Two-point process calibration (CAL): The device can be process-calibrated in 2 points to fit a given input signal. A low input signal (not necessarily 0%) is applied and the actual value is entered via PR 4500. Then a high signal (not necessarily 100%) is applied and the actual value is entered via PR 4500. If you accept to use the calibration, the device will work according to this new adjustment. If you later reject this menu point or choose another type of input signal the device will return to factory calibration.

Process simulation function (SIM): In the menu point "EN.SIM" it is possible to simulate an input signal by means of the arrow keys and thus control the output signal up or down. You must exit the menu by pressing ⏹ (no time-out).

The simulation function exits automatically, if the PR 4500 is detached.

Password (PASS): Here you can choose a password between 0000 and 9999 in order to protect the unit against unauthorized modifications to the configuration. The unit is delivered default without password.

Language (LANG): In the menu "LANG" you can choose between 7 different language versions of help texts that will appear in the menu. You can choose between UK, DE, FR, IT, ES, SE and DK.

Auto diagnosis

The device performs an advanced auto diagnosis of the internal circuits.

The following possible errors can be displayed in the front unit PR 4500.

CJ.ER - CJC sensor defect or CJC temperature outside range

FL.ER - Flash error

AO.ER - No load on the current output (only for S4...20 mA / S20...4 mA)

NO.CO - Connection error

IN.ER - Error levels on input

TY.ER - Configuration in PR 4500 does not match this product type

Selection of units

After choosing the input signal type you can choose which process units should be displayed in text line 2 (see table). By selection of temperature input the process value is always displayed in Celsius or Fahrenheit. This is selected in the menu point after selection of temperature input.

Safety readback & SIL operation

When the device is delivered with default configuration, the SIL function is disabled. The safety readback function (loop surveillance) can be selected in the menu O.RANGE, thus enabling the device to run in SIL mode.

In order to enable the SIL functionality, the menu item S4...20 mA or S20...4 mA MUST be selected.

All other assumptions and restrictions contained in the FMEDA report must also be observed.

Please note, however, that when safety readback is enabled, a sensor error will be indicated as an error on the analog output signal.

CJC

In the CJC menu you can choose between CJC connector and internal cold junction compensation. The CJC connector (PR 5910) must be ordered separately.

Routing diagram

If no key is activated for 1 minute, the display will return to the default state 1.0 without saving configuration changes.

- ⏪ Increase value / choose next parameter
- ⏩ Decrease value / choose previous parameter
- ⏹ Save the chosen value and proceed to the next menu
- ⏪⏩ Hold Back to previous menu / return to menu 1.0 without saving.

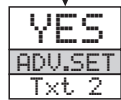
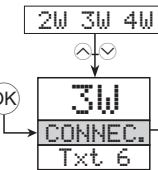
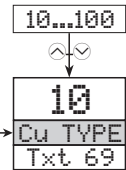
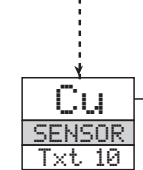
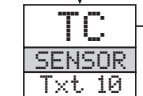
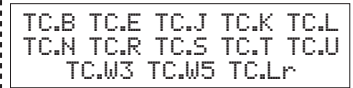
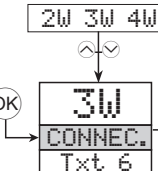
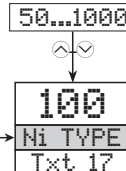
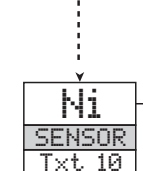
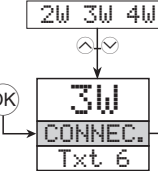
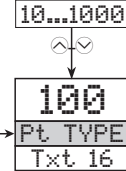
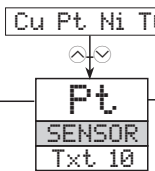
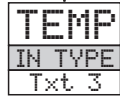
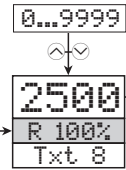
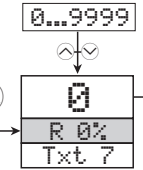
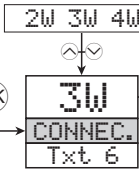
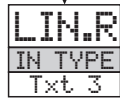
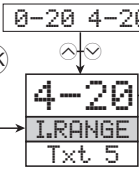
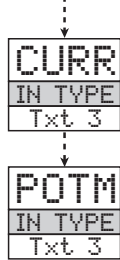
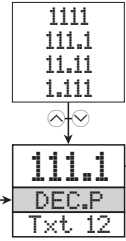
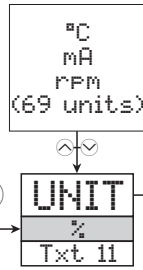
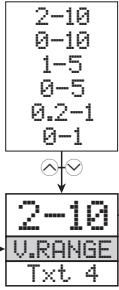
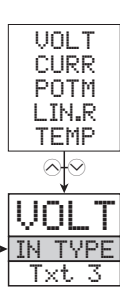
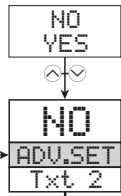
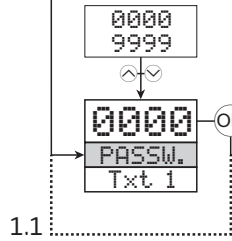
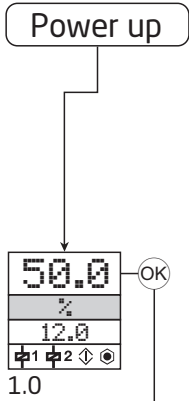

Continued on the page
Routing diagram ADV.SET

- 1.0 = Default state
Line 1 shows input signal.
Line 2 shows UNIT.
By pressing ⏪ and ⏩ simultaneously line 3 alternates between A.Out and TAG.
Line 4 shows communication status.
- 1.1 = Only if password-protected.
- 1.2 = Not valid for these input signals: 0...20 mA and voltage.
- 1.3 = Only if input signal is temperature.

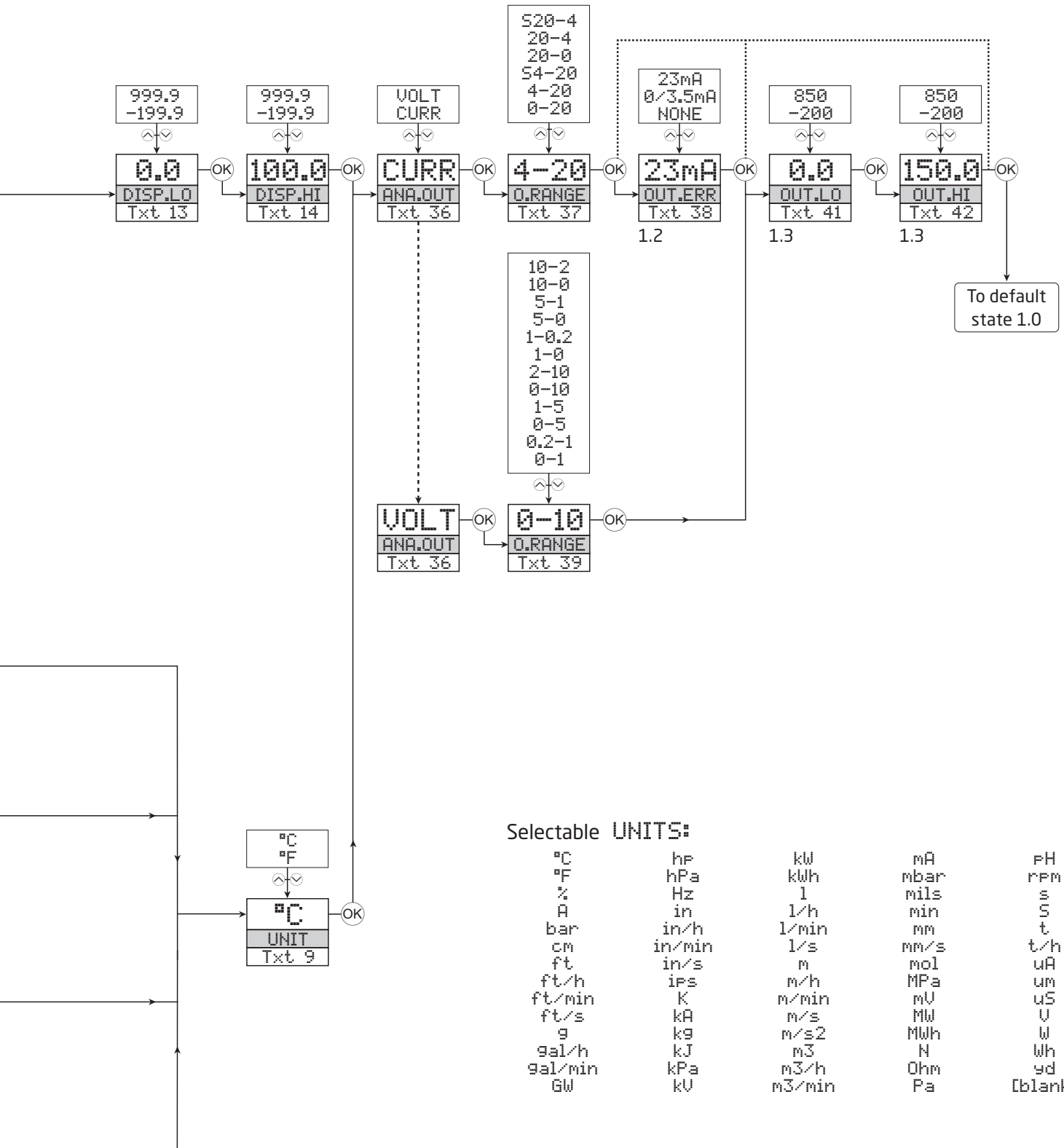

Routing diagram, advanced settings (ADV.SET)

2.0 In the submenu simulation (SIM) you must press **OK** to return to the default state 1.0.

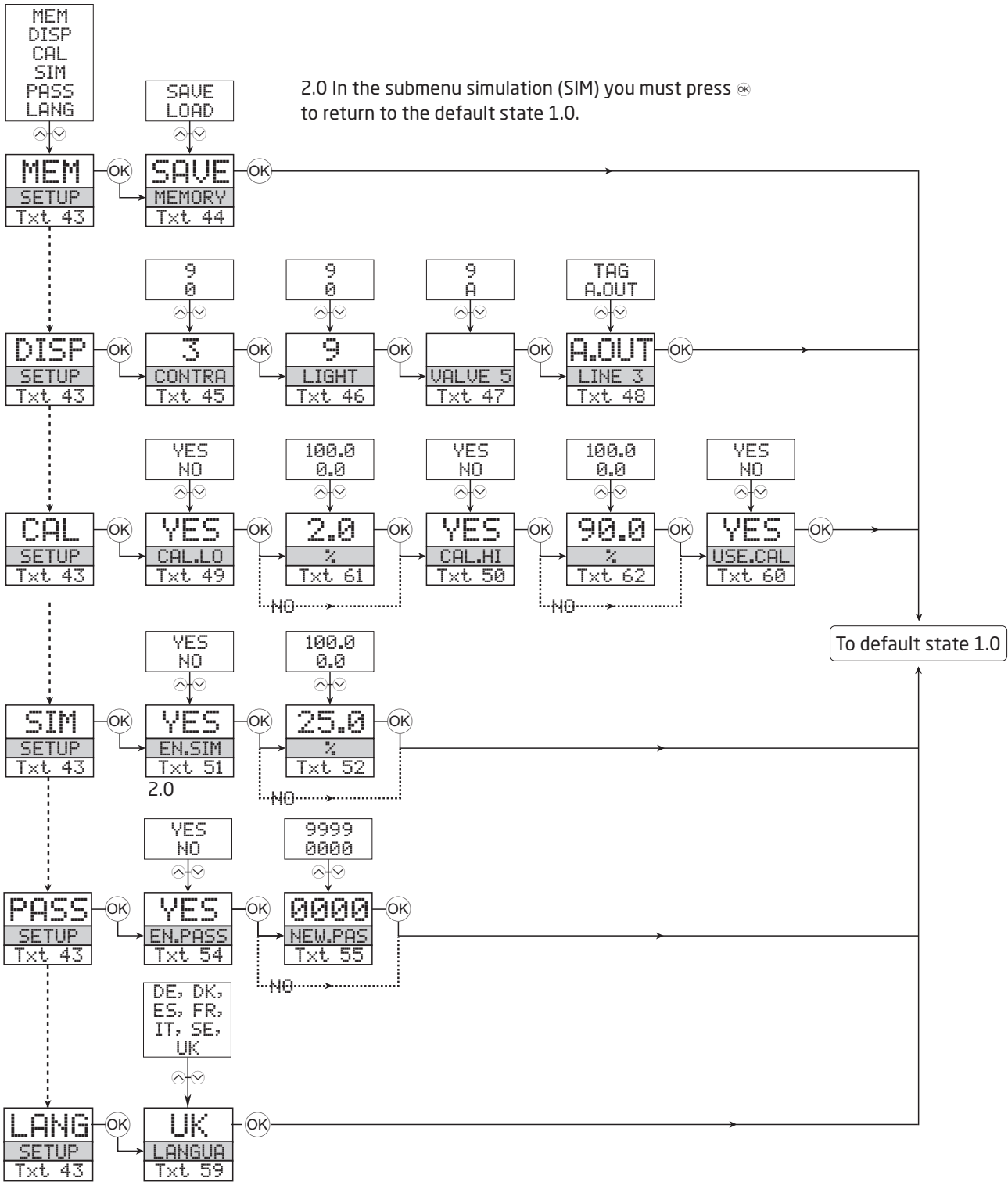

Help text overview

- [01] Set correct password
- [02] Enter advanced setup menu?
- [03] Select temperature input
 - Select potentiometer input
 - Select linear resistance input
 - Select current input
 - Select voltage input
- [04] Select 0.0-1 V input range
 - Select 0.2-1 V input range
 - Select 0-5 V input range
 - Select 1-5 V input range
 - Select 0-10 V input range
 - Select 2-10 V input range
- [05] Select 0-20 mA input range
 - Select 4-20 mA input range
- [06] Select 2-wire sensor connection
 - Select 3-wire sensor connection
 - Select 4-wire sensor connection
- [07] Set resistance value low
- [08] Set resistance value high
- [09] Select Celsius as temperature unit
 - Select Fahrenheit as temperature unit
- [10] Select TC sensor type
 - Select Ni sensor type
 - Select Pt sensor type
 - Select Cu sensor type
- [11] Select display unit
- [12] Select decimal point position
- [13] Set display range low
- [14] Set display range high
- [15] Set relays in % of input range
 - Select relays in display units
- [16] Select Pt10 as sensor type
 - Select Pt20 as sensor type
 - Select Pt50 as sensor type
 - Select Pt100 as sensor type
 - Select Pt200 as sensor type
 - Select Pt250 as sensor type
 - Select Pt300 as sensor type
 - Select Pt400 as sensor type
 - Select Pt500 as sensor type
 - Select Pt1000 as sensor type
- [17] Select Ni50 as sensor type
 - Select Ni100 as sensor type
 - Select Ni120 as sensor type
 - Select Ni1000 as sensor type
- [69] Select Cu10 as sensor type
 - Select Cu20 as sensor type
 - Select Cu50 as sensor type
 - Select Cu100 as sensor type
- [18] Select TC-B as sensor type
 - Select TC-E as sensor type
 - Select TC-J as sensor type
 - Select TC-K as sensor type
 - Select TC-L as sensor type
 - Select TC-N as sensor type
 - Select TC-R as sensor type
 - Select TC-S as sensor type
 - Select TC-T as sensor type
 - Select TC-U as sensor type
 - Select TC-W3 as sensor type
 - Select TC-W5 as sensor type
 - Select TC-Lr as sensor type
- [36] Select current as analog output type
 - Select voltage as analog output type
- [37] Select 0-20 mA output range
 - Select 4-20 mA output range
 - Select S4-20 mA with safety readback
 - Select 20-0 mA output range
 - Select 20-4 mA output range
 - Select S20-4 mA with safety readback
- [38] Select no error action - output undefined at error
 - Select downscale at error
 - Select NAMUR NE43 downscale at error
 - Select NAMUR NE43 upscale at error
- [39] Select 0.0-1 V output range
 - Select 0.2-1 V output range
 - Select 0-5 V output range
 - Select 1-5 V output range
 - Select 0-10 V output range
 - Select 2-10 V output range
 - Select 1-0.0 V output range
 - Select 1-0.2 V output range
 - Select 5-0 V output range
 - Select 5-1 V output range
 - Select 10-0 V output range
 - Select 10-2 V output range
- [41] Set temperature for analog output low
- [42] Set temperature for analog output high
- [43] Enter password setup
 - Enter simulation mode
 - Perform process calibration
 - Enter display setup
 - Perform memory operations
- [44] Load saved configuration into 4114
 - Save 4116 configuration in PR 4500
- [45] Adjust LCD contrast
- [46] Adjust LCD backlight
- [47] Write a 6-character device TAG
- [48] Analog output value is shown in display line 3
 - Device TAG is shown in display line 3
- [49] Calibrate input low to process value?
- [50] Calibrate input high to process value?
- [51] Enable simulation mode?
- [52] Set the input simulation value
- [54] Enable password protection?
- [55] Set new password
- [59] Select language
- [60] Use process calibration values?
- [61] Set value for low calibration point
- [62] Set value for high calibration point
- [63] Select CJC connector (accessory)
 - Select internal temperature sensor

Document history

The following list provides notes concerning revisions of this document.

Rev. ID	Date	Notes
105	2011	EU-RO marine approval added.
106	2136	UKCA added.

We are near you, *all over the world*

Our trusted red boxes are supported wherever you are

All our devices are backed by expert service and a 5-year warranty. With each product you purchase, you receive personal technical support and guidance, day-to-day delivery, repair without charge within the warranty period and easily accessible documentation.

We are headquartered in Denmark, and have offices and authorized partners the world over. We are a local

business with a global reach. This means that we are always nearby and know your local markets well. We are committed to your satisfaction and provide PERFORMANCE MADE SMARTER all around the world.

For more information on our warranty program, or to meet with a sales representative in your region, visit prelectronics.com.

Benefit today from *PERFORMANCE MADE SMARTER*

PR electronics is the leading technology company specialized in making industrial process control safer, more reliable and more efficient. Since 1974, we have been dedicated to perfecting our core competence of innovating high precision technology with low power consumption. This dedication continues to set new standards for products communicating, monitoring and connecting our customers' process measurement points to their process control systems.

Our innovative, patented technologies are derived from our extensive R&D facilities and from having a great understanding of our customers' needs and processes. We are guided by principles of simplicity, focus, courage and excellence, enabling some of the world's greatest companies to achieve PERFORMANCE MADE SMARTER.